



# STD5N20

## N-CHANNEL 200V - 0.6Ω - 5A DPAK MESH OVERLAY™ MOSFET

TYPE	V <sub>DSS</sub>	R <sub>DS(on)</sub>	I <sub>D</sub>
STD5N20	200 V	< 0.8 Ω	5 A

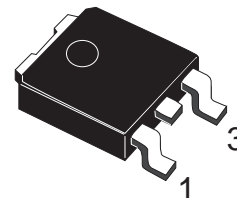
- TYPICAL R<sub>DS(on)</sub> = 0.6 Ω
- EXTREMELY HIGH dv/dt CAPABILITY
- 100% AVALANCHE TESTED
- ADD SUFFIX "T4" FOR ORDERING IN TAPE & REEL

### DESCRIPTION

Using the latest high voltage MESH OVERLAY™ process, STMicroelectronics has designed an advanced family of power MOSFETs with outstanding performance. The new patented STRIP layout coupled with the Company's proprietary edge termination structure, makes it suitable in converters for lighting applications.

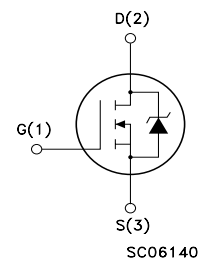
### APPLICATIONS

- HIGH CURRENT, HIGH SPEED SWITCHING
- SWITCH MODE POWER SUPPLIES (SMPS)
- DC-DC CONVERTERS FOR TELECOM, INDUSTRIAL, AND LIGHTING EQUIPMENT



**DPAK  
TO-252**

### INTERNAL SCHEMATIC DIAGRAM



### ABSOLUTE MAXIMUM RATINGS

Symbol	Parameter	Value	Unit
V <sub>DS</sub>	Drain-source Voltage (V <sub>GS</sub> = 0)	200	V
V <sub>DGR</sub>	Drain-gate Voltage (R <sub>GS</sub> = 20 kΩ)	200	V
V <sub>GS</sub>	Gate- source Voltage	±20	V
I <sub>D</sub>	Drain Current (continuous) at T <sub>C</sub> = 25°C	5	A
I <sub>D</sub>	Drain Current (continuous) at T <sub>C</sub> = 100°C	3.5	A
I <sub>DM</sub> (•)	Drain Current (pulsed)	20	A
P <sub>TOT</sub>	Total Dissipation at T <sub>C</sub> = 25°C	45	W
	Derating Factor	0.36	W/°C
dv/dt (1)	Peak Diode Recovery voltage slope	5	V/ns
T <sub>stg</sub>	Storage Temperature	-65 to 150	°C
T <sub>j</sub>	Max. Operating Junction Temperature	150	°C

(•) Pulse width limited by safe operating area

(1) I<sub>SD</sub> ≤ 5A, di/dt ≤ 300A/μs, V<sub>DD</sub> ≤ V<sub>I(BR)DSS</sub>, T<sub>j</sub> ≤ T<sub>JMAX</sub>.  
(\*\*) Limited only by Maximum Temperature Allowed

## STD5N20

### THERMAL DATA

Rthj-case	Thermal Resistance Junction-case Max	2.77	°C/W
Rthj-amb	Thermal Resistance Junction-ambient Max	100	°C/W
Rthc-sink	Thermal Resistance Case-sink Typ	1.5	°C/W
T <sub>l</sub>	Maximum Lead Temperature For Soldering Purpose	275	°C

### AVALANCHE CHARACTERISTICS

Symbol	Parameter	Max Value	Unit
I <sub>AR</sub>	Avalanche Current, Repetitive or Not-Repetitive (pulse width limited by T <sub>j</sub> max)	5	A
E <sub>AS</sub>	Single Pulse Avalanche Energy (starting T <sub>j</sub> = 25 °C, I <sub>D</sub> = I <sub>AR</sub> , V <sub>DD</sub> = 50 V)	130	mJ

### ELECTRICAL CHARACTERISTICS (T<sub>CASE</sub> = 25 °C UNLESS OTHERWISE SPECIFIED) OFF

Symbol	Parameter	Test Conditions	Min.	Typ.	Max.	Unit
V <sub>(BR)DSS</sub>	Drain-source Breakdown Voltage	I <sub>D</sub> = 250 μA, V <sub>GS</sub> = 0	200			V
I <sub>DSS</sub>	Zero Gate Voltage Drain Current (V <sub>GS</sub> = 0)	V <sub>DS</sub> = Max Rating V <sub>DS</sub> = Max Rating, T <sub>C</sub> = 125 °C			1 50	μA μA
I <sub>GSS</sub>	Gate-body Leakage Current (V <sub>DS</sub> = 0)	V <sub>GS</sub> = ±20V			±100	nA

### ON (1)

Symbol	Parameter	Test Conditions	Min.	Typ.	Max.	Unit
V <sub>GS(th)</sub>	Gate Threshold Voltage	V <sub>DS</sub> = V <sub>GS</sub> , I <sub>D</sub> = 250μA	2	3	4	V
R <sub>DS(on)</sub>	Static Drain-source On Resistance	V <sub>GS</sub> = 10V, I <sub>D</sub> = 2.5 A		0.7	0.8	Ω
I <sub>D(on)</sub>	On State Drain Current	V <sub>DS</sub> > I <sub>D(on)</sub> × R <sub>DS(on)max</sub> , V <sub>GS</sub> = 10V	5			A

### DYNAMIC

Symbol	Parameter	Test Conditions	Min.	Typ.	Max.	Unit
g <sub>fs</sub> (1)	Forward Transconductance	V <sub>DS</sub> > I <sub>D(on)</sub> × R <sub>DS(on)max</sub> , I <sub>D</sub> = 2.5A	1.5	4		S
C <sub>iss</sub>	Input Capacitance	V <sub>DS</sub> = 25V, f = 1 MHz, V <sub>GS</sub> = 0		350		pF
C <sub>oss</sub>	Output Capacitance			70		pF
C <sub>rss</sub>	Reverse Transfer Capacitance			35		pF

**ELECTRICAL CHARACTERISTICS (CONTINUED)**

**SWITCHING ON**

Symbol	Parameter	Test Conditions	Min.	Typ.	Max.	Unit
$t_{d(on)}$	Turn-on Delay Time	$V_{DD} = 100\text{ V}, I_D = 3\text{ A}$ $R_G = 4.7\Omega, V_{GS} = 10\text{ V}$ (see test circuit, Figure 3)		18		ns
$t_r$	Rise Time			30		ns
$Q_g$	Total Gate Charge	$V_{DD} = 160\text{ V}, I_D = 6\text{ A},$ $V_{GS} = 10\text{ V}$		19	27	nC
$Q_{gs}$	Gate-Source Charge			4.5		nC
$Q_{gd}$	Gate-Drain Charge			7.5		nC

**SWITCHING OFF**

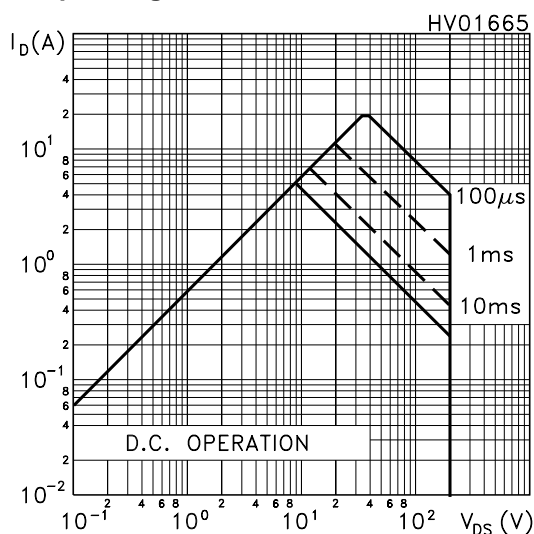
Symbol	Parameter	Test Conditions	Min.	Typ.	Max.	Unit
$t_{r(Voff)}$	Off-voltage Rise Time	$V_{DD} = 160\text{ V}, I_D = 6\text{ A},$ $R_G = 4.7\Omega, V_{GS} = 10\text{ V}$ (see test circuit, Figure 5)		40		ns
$t_f$	Fall Time			10		ns
$t_c$	Cross-over Time			65		ns

**SOURCE DRAIN DIODE**

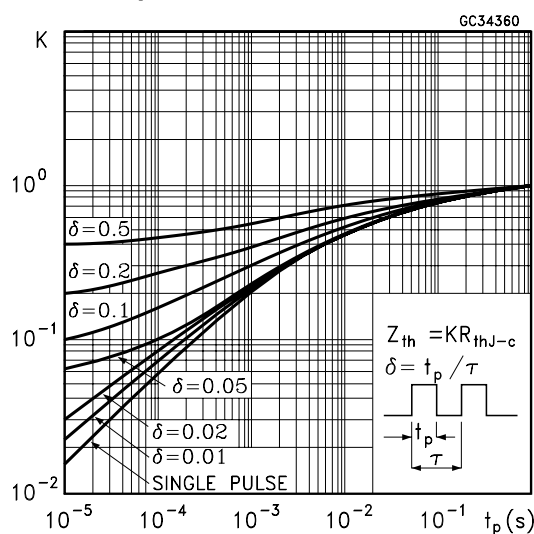
Symbol	Parameter	Test Conditions	Min.	Typ.	Max.	Unit
$I_{SD}$	Source-drain Current				6	A
$I_{SDM(2)}$	Source-drain Current (pulsed)				24	A
$V_{SD(1)}$	Forward On Voltage	$I_{SD} = 6\text{ A}, V_{GS} = 0$			1.5	V
$t_{rr}$	Reverse Recovery Time	$I_{SD} = 6\text{ A}, di/dt = 100\text{ A}/\mu\text{s}$ $V_{DD} = 100\text{ V}, T_J = 150^\circ\text{C}$ (see test circuit, Figure 5)		155		ns
$Q_{rr}$	Reverse Recovery Charge			700		nC
$I_{RRM}$	Reverse Recovery Current			9		A

Note: 1. Pulsed: Pulse duration = 300  $\mu\text{s}$ , duty cycle 1.5 %.  
2. Pulse width limited by safe operating area.

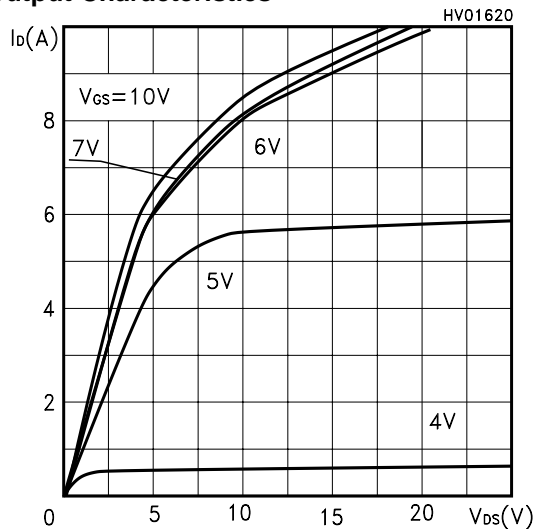
**Safe Operating Area**



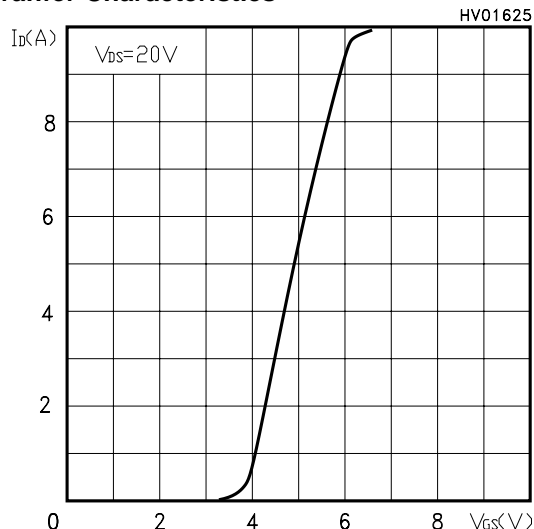
**Thermal Impedance**



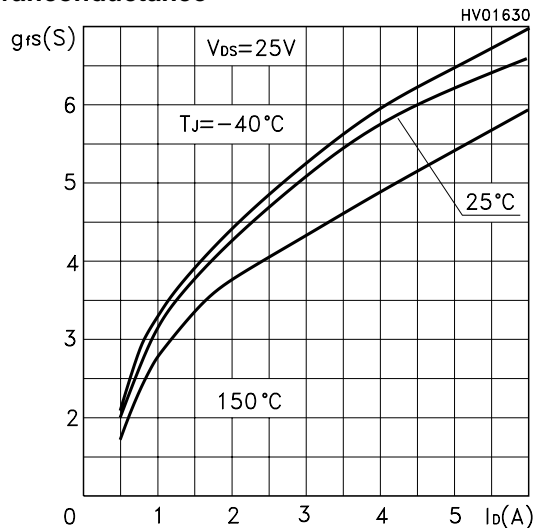
Output Characteristics



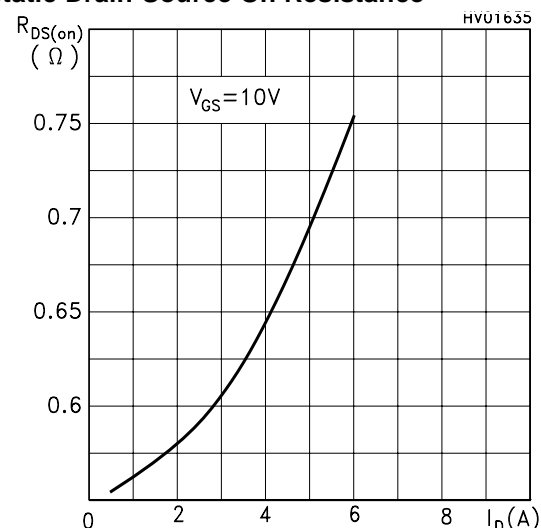
Transfer Characteristics



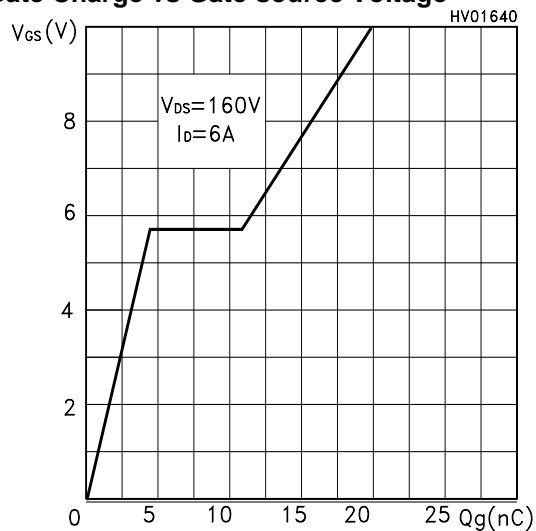
Transconductance



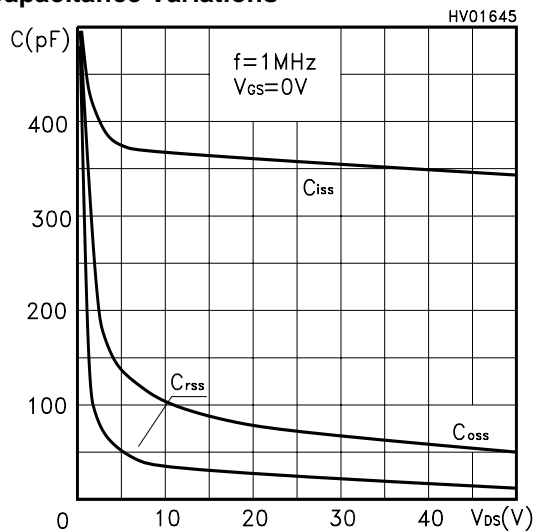
Static Drain-Source On Resistance



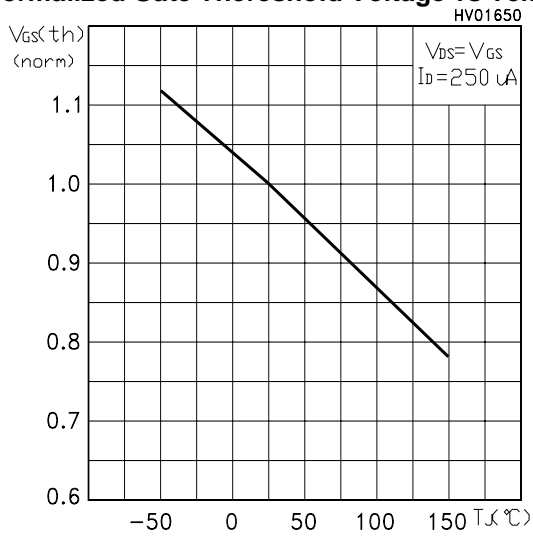
Gate Charge vs Gate-source Voltage



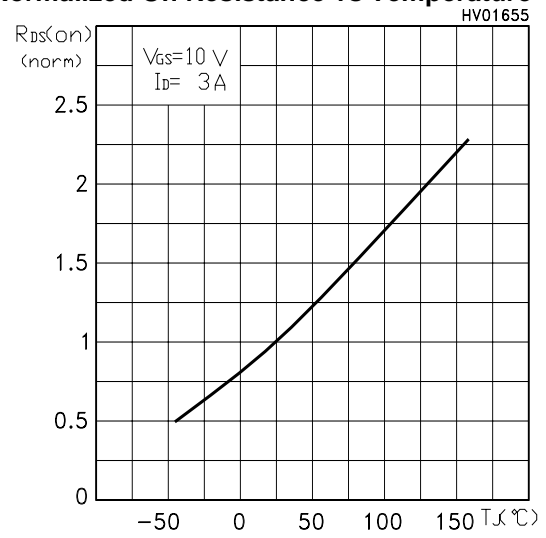
Capacitance Variations



**Normalized Gate Threshold Voltage vs Temp.**



**Normalized On Resistance vs Temperature**



**Source-drain Diode Forward Characteristics**

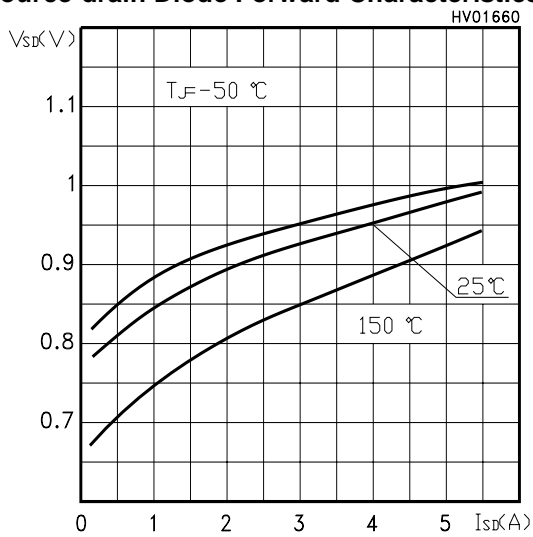


Fig. 1: Unclamped Inductive Load Test Circuit



Fig. 2: Unclamped Inductive Waveform



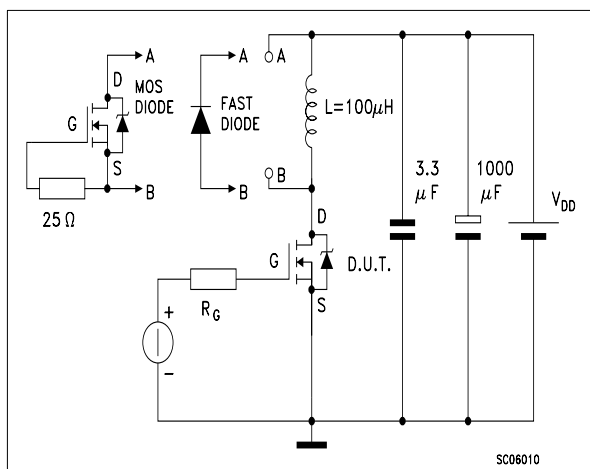
Fig. 3: Switching Times Test Circuit For Resistive Load



Fig. 4: Gate Charge test Circuit

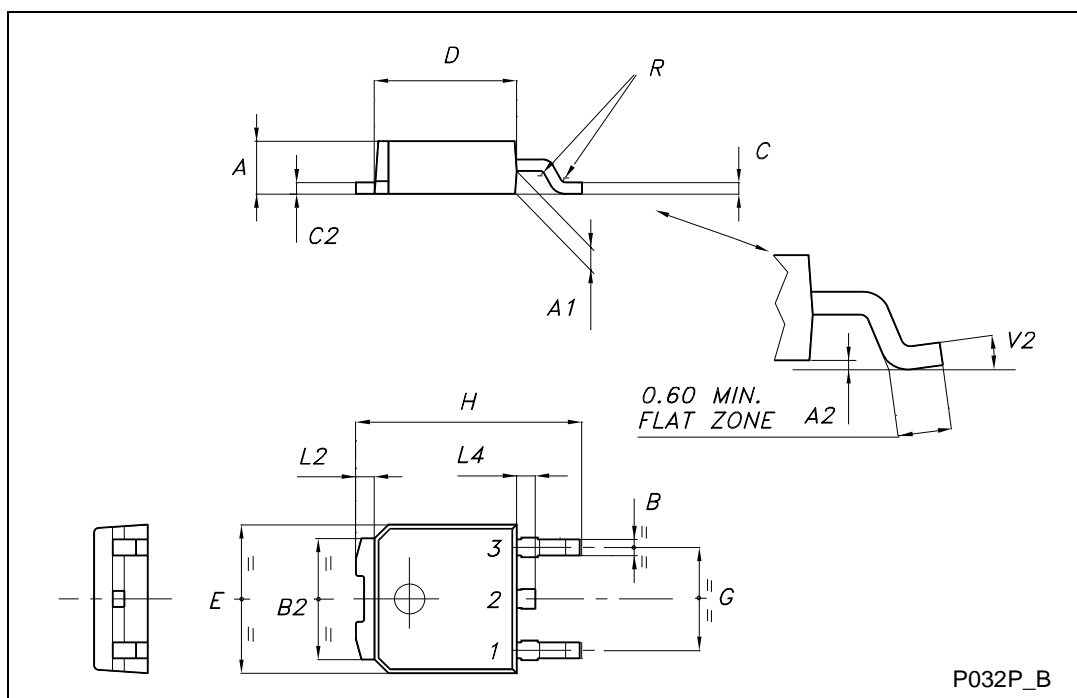


Fig. 5: Test Circuit For Inductive Load Switching And Diode Recovery Times



TO-252 (DPAK) MECHANICAL DATA

DIM.	mm			inch		
	MIN.	TYP.	MAX.	MIN.	TYP.	MAX.
A	2.20		2.40	0.087		0.094
A1	0.90		1.10	0.035		0.043
A2	0.03		0.23	0.001		0.009
B	0.64		0.90	0.025		0.035
B2	5.20		5.40	0.204		0.213
C	0.45		0.60	0.018		0.024
C2	0.48		0.60	0.019		0.024
D	6.00		6.20	0.236		0.244
E	6.40		6.60	0.252		0.260
G	4.40		4.60	0.173		0.181
H	9.35		10.10	0.368		0.398
L2		0.8			0.031	
L4	0.60		1.00	0.024		0.039
V2	0°		8°	0°		0°



Information furnished is believed to be accurate and reliable. However, STMicroelectronics assumes no responsibility for the consequences of use of such information nor for any infringement of patents or other rights of third parties which may result from its use. No license is granted by implication or otherwise under any patent or patent rights of STMicroelectronics. Specifications mentioned in this publication are subject to change without notice. This publication supersedes and replaces all information previously supplied. STMicroelectronics products are not authorized for use as critical components in life support devices or systems without express written approval of STMicroelectronics.

© The ST logo is a registered trademark of STMicroelectronics

© 2002 STMicroelectronics - Printed in Italy - All Rights Reserved  
STMicroelectronics GROUP OF COMPANIES

Australia - Brazil - Canada - China - Finland - France - Germany - Hong Kong - India - Israel - Italy - Japan - Malaysia - Malta - Morocco  
Singapore - Spain - Sweden - Switzerland - United Kingdom - United States.

© <http://www.st.com>